

PROPRIETARY INFORMATION
COMPANY CONFIDENTIAL

REV.	ECN. NO.	DESCRIPTION	ENG	DATE
X1		INITIAL	AXL	11/5/2021
X2		UPDATED DRAWINGS	KEEN	03/10/2022

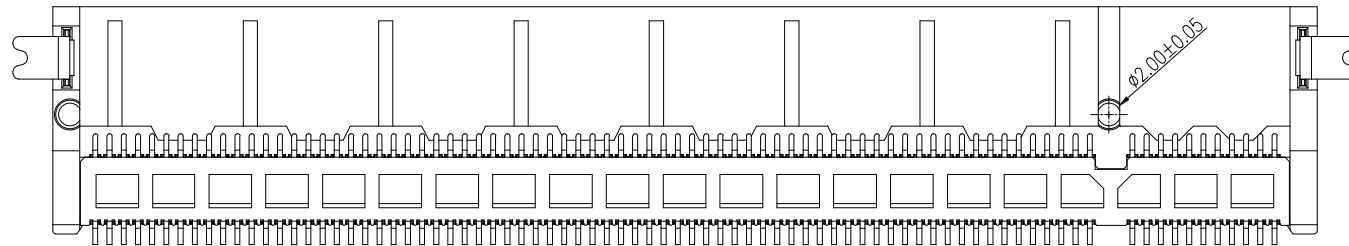
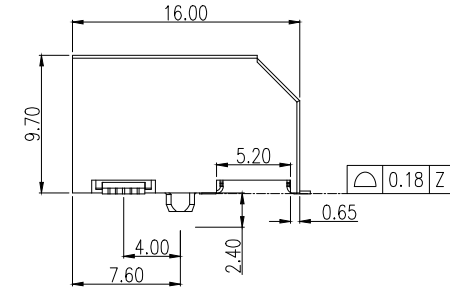
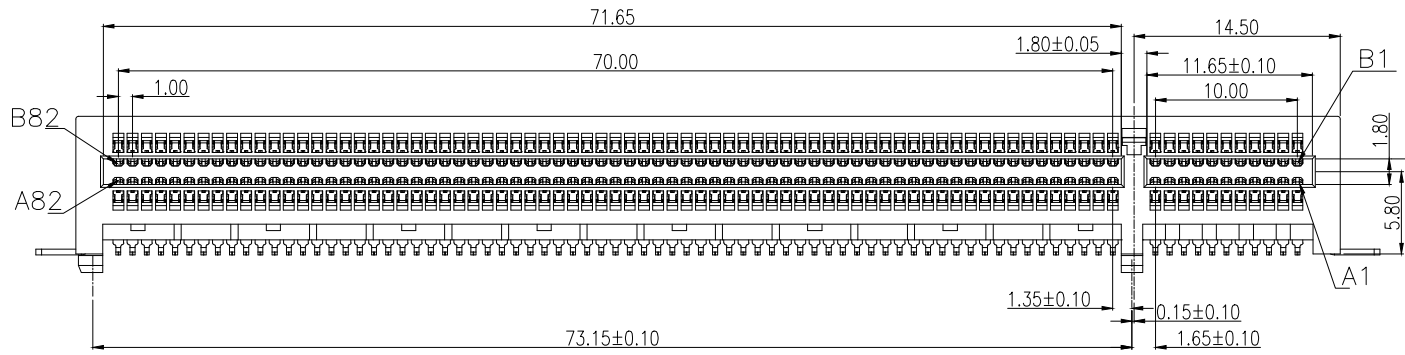
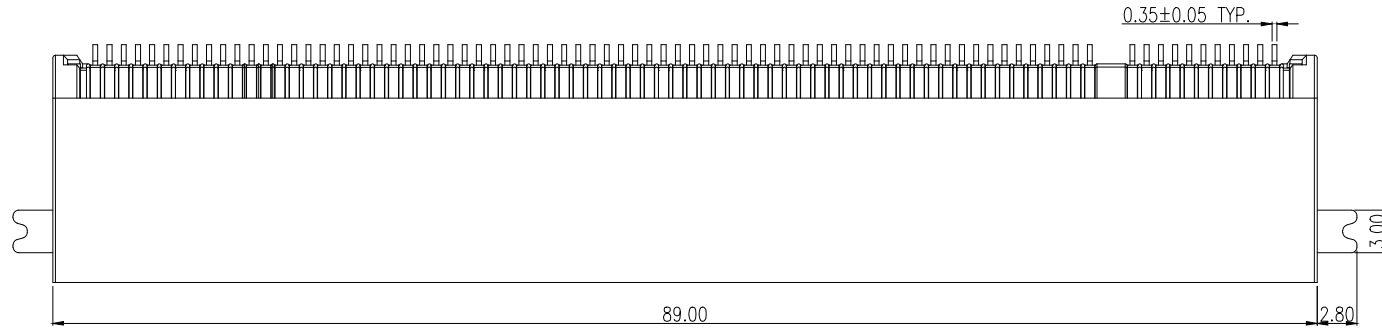

GENERAL TOLERANCE X± 0.35 .X± 0.30 .XX± 0.20 .XXX± 0.10	ANGLE TOLERANCE X°± 1.0° .X°± .XX°± .XXX°±	DRAWN KEEN	DATE 03/10/2022		TITLE RIGHT ANGLE PCI GEN5 CONN.
MATL	FINISH	CHECKED	DATE		PART NUMBER 106-10086-0X
SCALE 1:1	UNIT mm	APPROVED	DATE	DRAWING NO. 106-10086	SIZE A4 REV. X2
SHEET 1 OF 3					

PROPRIETARY INFORMATION
COMPANY CONFIDENTIAL

REV.	ECN. NO.	DESCRIPTION	ENG	DATE
		SEE SHEET 1		

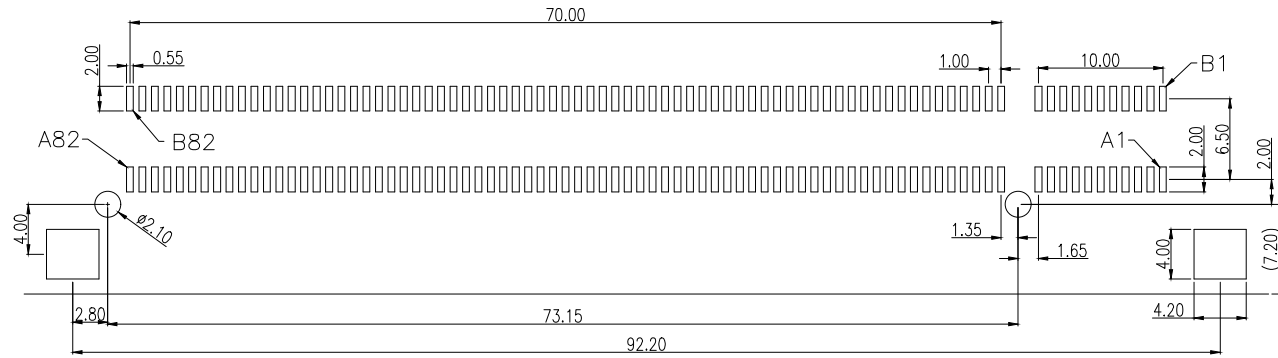

RECOMMENDED PCB LAYOUT, STENCIL THICKNESS 0.20mm
TOLERANCE: ±0.05mm

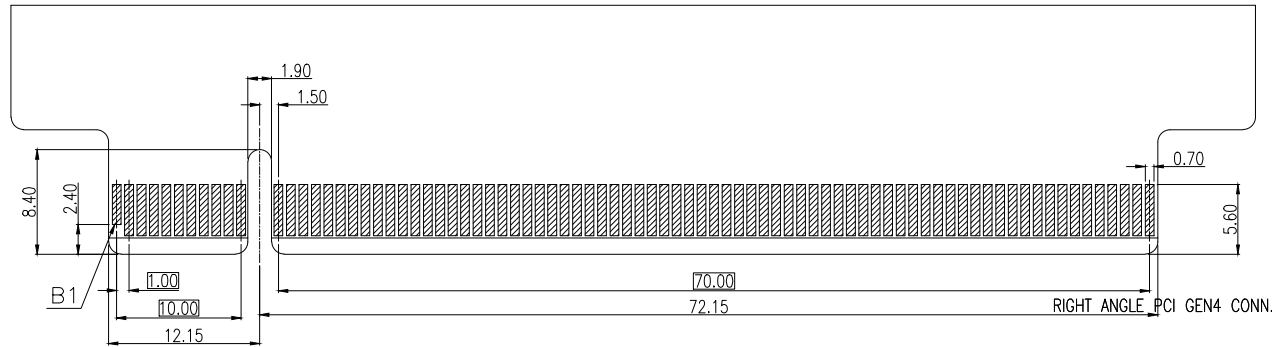

I/O PANEL DIRECTION SECONDARY (SOLDER) SIDE

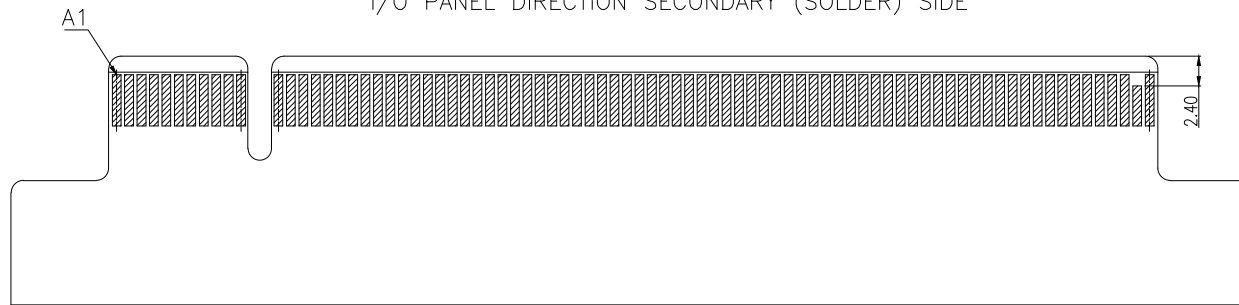
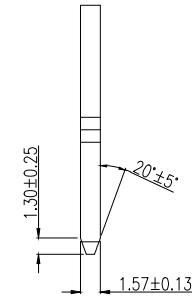

RECOMMENDED ADD-IN-CARD
TOLERANCE: ±0.05mm

GENERAL TOLERANCE X ± 0.35 .X ± 0.30 .XX ± 0.20 .XXX ± 0.10	ANGLE TOLERANCE X° ± 1.0° .X° ± .XX° ± .XXX° ±	DRAWN KEEN	DATE 03/10/2022		
MATL	FINISH	CHECKED	DATE		TITLE RIGHT ANGLE PCI GEN5 CONN.
SCALE 1:1	UNIT mm	APPROVED	DATE	PART NUMBER 106-10086-0X	
SHEET 2 OF 3				DRAWING NO. 106-10086	SIZE A4 REV. X2

PROPRIETARY INFORMATION
COMPANY CONFIDENTIAL

REV.	ECN. NO.	DESCRIPTION	ENG	DATE
		SEE SHEET 1		

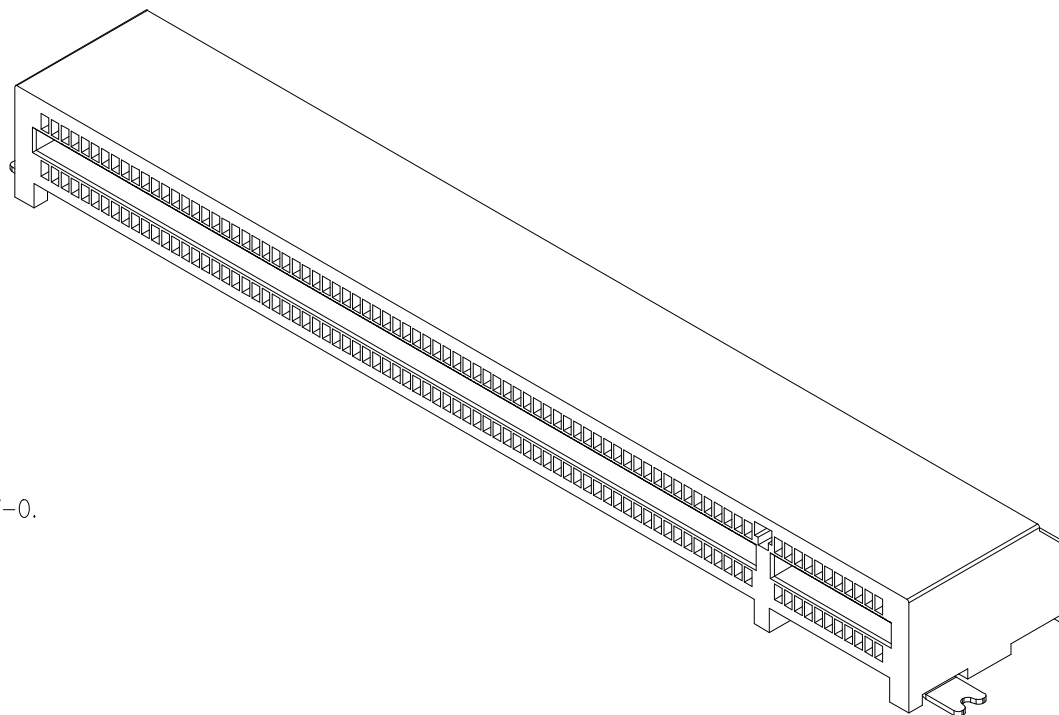

NOTES :

1.MATERIAL:

- 1-1. HOUSING: HIGH TEMPERATURE THERMO PLASTIC,LCP COLOR: BLACK,UL94V-0.
- 1-2. CONTACT: COPPER ALLOY.
- 1-3. HOLD DOWN PLATE: COPPER ALLOY

2.FINISH:

- 2-1. CONTACT: GOLD PLATING ON CONTACT AREA .
MATTE TIN(100u" MIN) PLATING ON SOLDER TAILS .
NICKEL(50u"~100u") UNDER PLATING OVERALL.
- 2-2. HOLD DOWN (SOLDER TAB):
100u" MIN MATTE TIN OVER;
50u" MIN NICKEL UNDER PLATING OVERALL.

3.PART NO. DESCRIPTION:

106-10084-0X

- 1: GOLD 5u" MIN
- 2: GOLD 15u" MIN
- 3: GOLD 30u" MIN

GENERAL TOLERANCE X± 0.35 .X± 0.30 .XX± 0.20 .XXX± 0.10		ANGLE TOLERANCE X°± 1.0° .X°± .XX°± .XXX°±		DRAWN KEEN	DATE 03/10/2022		TITLE RIGHT ANGLE PCI GEN5 CONN.
MATERIAL		FINISH		CHECKED	DATE		PART NUMBER 106-10086-0X
SCALE 1:1	UNIT mm	APPROVED		DATE	DRAWING NO. 106-10086		SIZE A4
SHEET 3 OF 3						REV. X2	