

PROPRIETARY INFORMATION
COMPANY CONFIDENTIAL

REV.	ECN. NO.	DESCRIPTION	ENG	DATE
X1		ISSUED	KYLE	12/04/2018

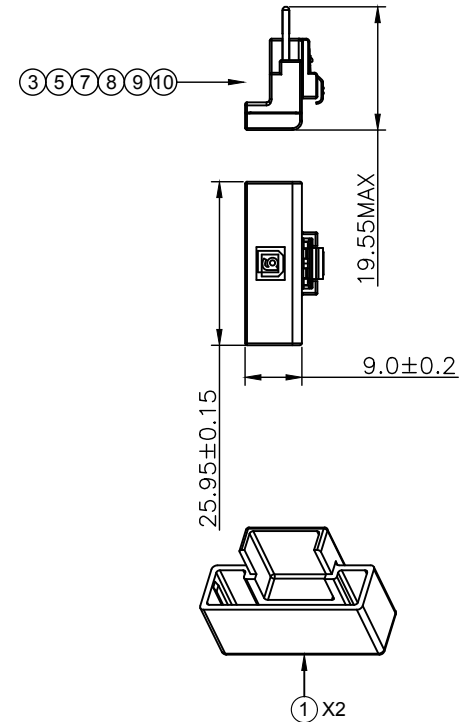
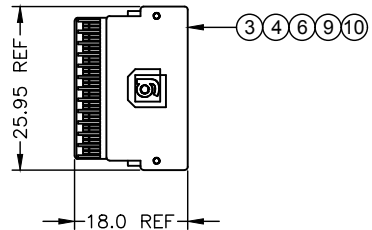
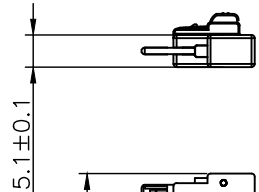
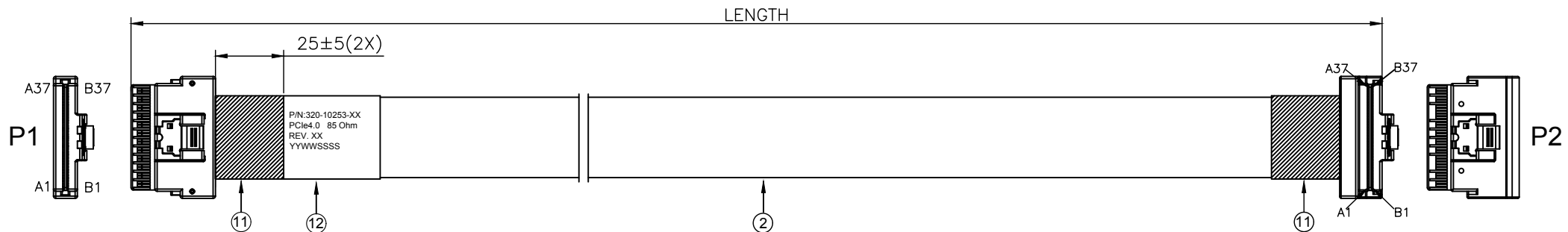

GENESIS P/N	LENGTH(mm)	TOLERANCE(mm)
320-10253-01	152	±10
320-10253-02	300	±10
320-10253-03	500	±15
320-10253-04	700	±15
320-10253-05	1000	±15

ITEM	NAME	Q'TY	DESCRIPTION	NOTE
12	LABEL	1	WHITE LABEL, 60*30MM(REF)	
11	ACETATE TAPE	A/R	ACETATE TAPE, W=25MM, BLACK	
10	RIVET	4	RIVET FOR SFF-8654	
9	LATCH	2	LATCH FOR SFF-8654	
8	BACK COVER	1	BACK COVER FOR SFF-8654 8i R/A, BLACK	
7	HOUSING	1	HOUSING FOR SFF-8654 8i R/A, BLACK	
6	HOUSING	1	HOUSING FOR SFF-8654 8i STR, BLACK	
5	INNER MOLD	1	INNER MOLDING FOR SFF-8654 8i R/A, BLACK	
4	INNER MOLD	1	INNER MOLDING FOR SFF-8654 8i STR, BLACK	
3	8654 8i PCB	2	PCB FOR SLIMLINE SAS 8i STR, AU30u"	
2	FLAT CABLE	A/R	FLATFAST CABLE, 85 OHM, 32 AWG,	
1	DUST CAP	2	DUST CAP FOR SFF-8654 8i, PE, NATURAL	

RoHS Compliant

GENERAL TOLERANCE X ± .X ± 0.40 .XX ± 0.30 .XXX ± 0.20	ANGLE TOLERANCE X° ± 5.0° .X° ± 3.0° .XX° ± 2.0° .XXX° ± 1.0°	DRAWN KYLE	DATE 12/04/2018
MATERIAL SEE BOM		CHECKED	DATE
FINISH SEE BOM		APPROVED	DATE
SCALE N/A	UNIT mm	SHEET 1 OF 2	

genesis
connected solutions

TITLE: SlimSAS 8i STR TO RAD Cable Ass'y
PCIe4.0, FLATFAST, 85 Ohm

PART NUMBER:
320-10253-XX

DRAWING NO.
320-10253

SIZE *A4*
REV. *X1*

WIRING TABLE

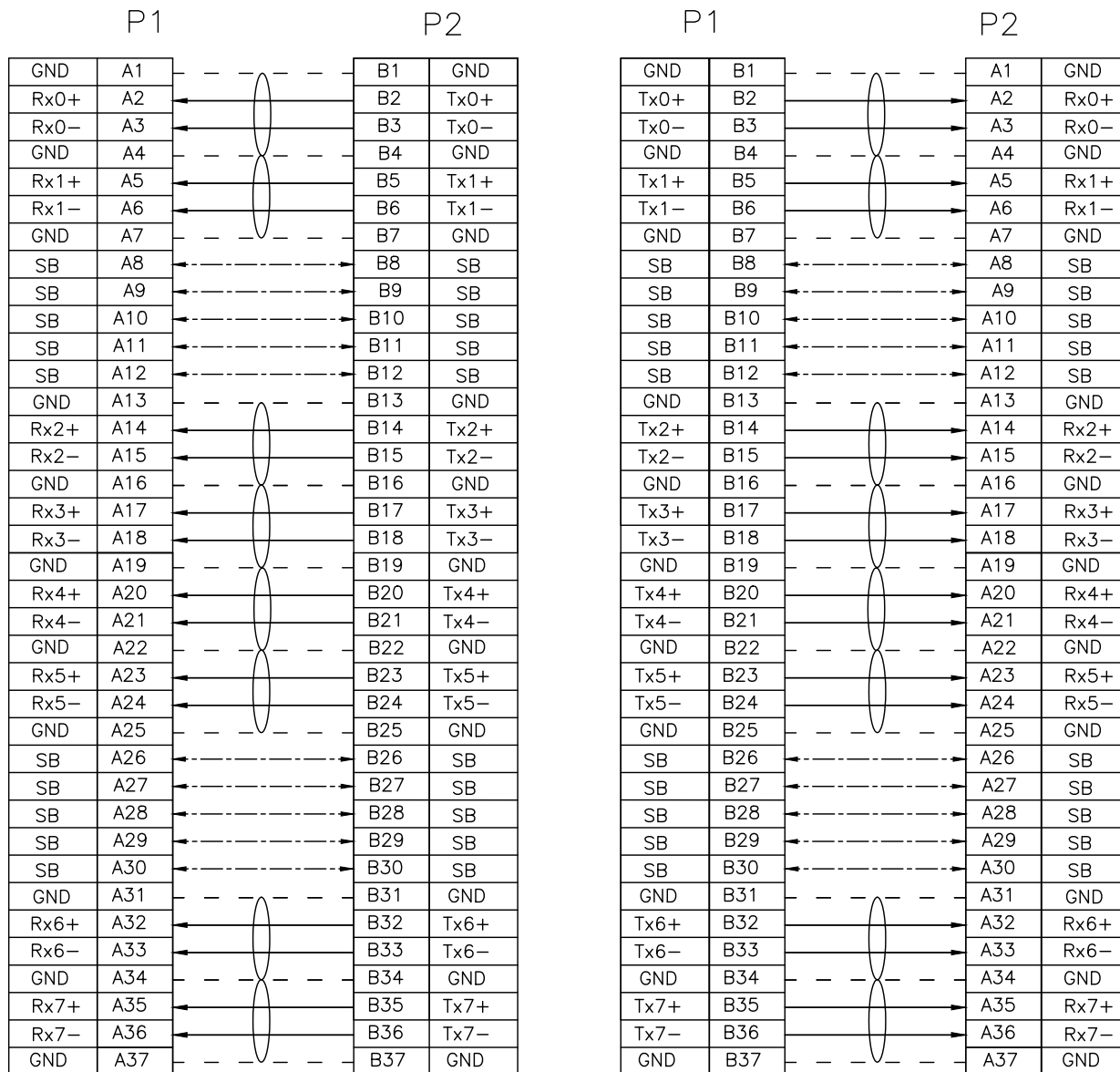

A1,A4,A7,A13,A16,A19,A22,A25,A31,A34,A37,
B1,B4,B7,B13,B16,B19,B22,B25,B31,B34,B37 Grounded on PCB

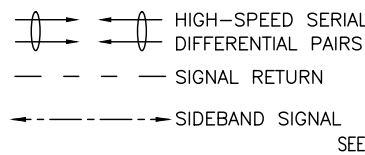

LABEL INFORMATION

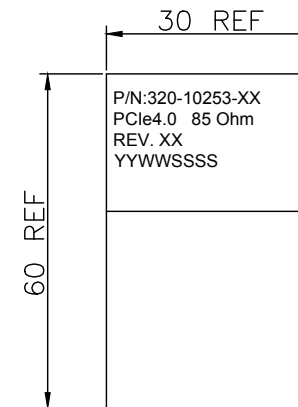

FONT: ARIAL
HEIGHT: 2.0mm Min

TEST CONDITIONS:

- 100% OPEN & SHORT & MISS-WIRING & INTERMITTENCE TEST.
- CONDUCTIVE RESISTANCE: 3Ω MAX.
- INSULATION RESISTANCE: 10 MΩ
- HI-POT TEST: 300VDC FOR 10ms.
- THIS PRODUCT MEETS PCIe 4.0

RoHS Compliant

GENERAL TOLERANCE X ± .X ± 0.40 .XX ± 0.30 .XXX ± 0.20	ANGLE TOLERANCE X° ± 5.0° .X° ± 3.0° .XX° ± 2.0° .XXX° ± 1.0°	DRAWN KYLE	DATE 12/04/2018	 TITLE: SlimSAS 8i STR TO RAD Cable Ass'Y PCIe4.0, FLATFAST, 85 Ohm
MATL SEE BOM	FINISH SEE BOM	CHECKED	DATE	
SCALE N/A	UNIT mm	APPROVED	DATE	DRAWING NO. 320-10253
SHEET 2 OF 2				SIZE A4 REV. X1