

PROPRIETARY INFORMATION
COMPANY CONFIDENTIAL

REV.	ECN. NO.	DESCRIPTION	ENG	DATE
A		INITIAL	Knight	05/07/15'
B		ADD ASSEMBLE VIEW	Knight	12/16/15'
C		ADD FEMALE HEIGHT 3.75MM AND 7.75MM OPTION	Knight	12/18/15'

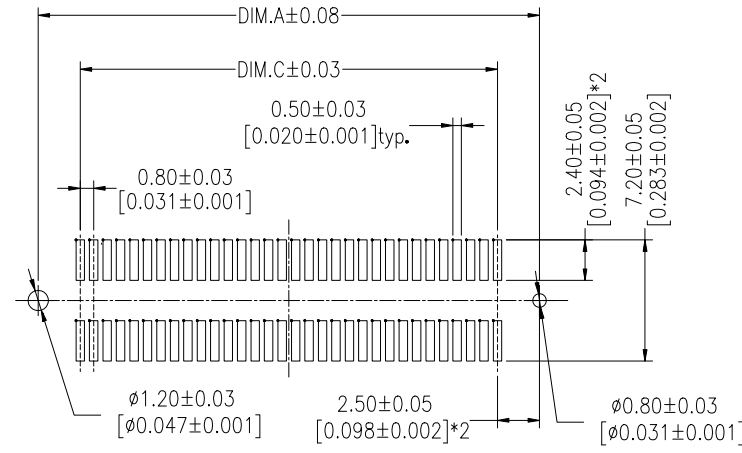
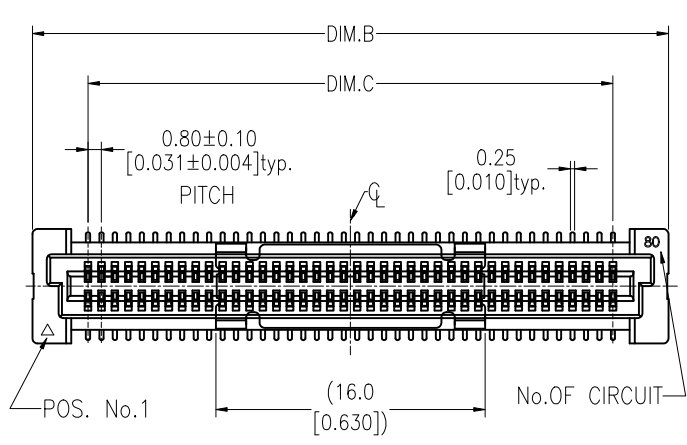

RECOMMENDED P.C.B LAYOUT(TOP SIDE)
(PCB BOARD TOLERANCE:±0.05)

- NOTES:
1. Current Rating:0.5 AMP
 2. Contact Resistance:30mΩ Max
 3. Withstand Voltage:100V AC/DC
 4. Insulation Resistance:500MΩ Min
 5. Operation Temperature:-40℃ to+125 ℃

ORDER INFORMATION
WAFV-XX XX - B N 2 0 R
① ② ③ ④ ⑤ ⑥ ⑦

1. TYPE:
WAFV-20:0.80mm B TO B FEMALE TYPE
SMT FEMALE HEIGHT 3.75
WAFV-40:0.80mm B TO B FEMALE TYPE
SMT FEMALE HEIGHT 7.75
WAFV-41:0.80mm B TO B FEMALE TYPE
SMT FEMALE HEIGHT 11.75
2. POSITIONS:
XX: SEE POSITIONS NUMBER
3. INSULATOR MATERIAL:
B: LCP
4. INSULATOR COLOR:
N: NATURAL
5. CONTACT PLATING:
2: GOLD 3u"
6. SHIELD PLATING:
0: NONE
SHIELD
7. PACKING
R: TAPE&REEL

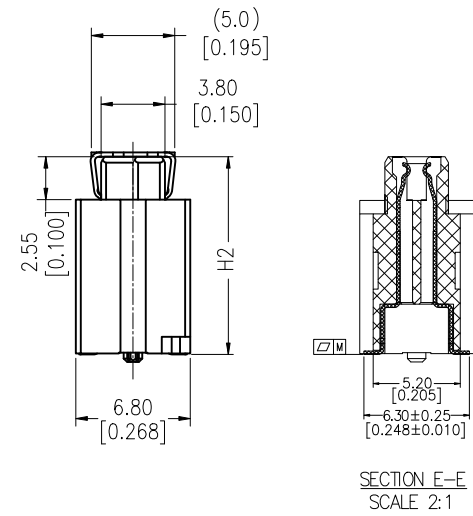
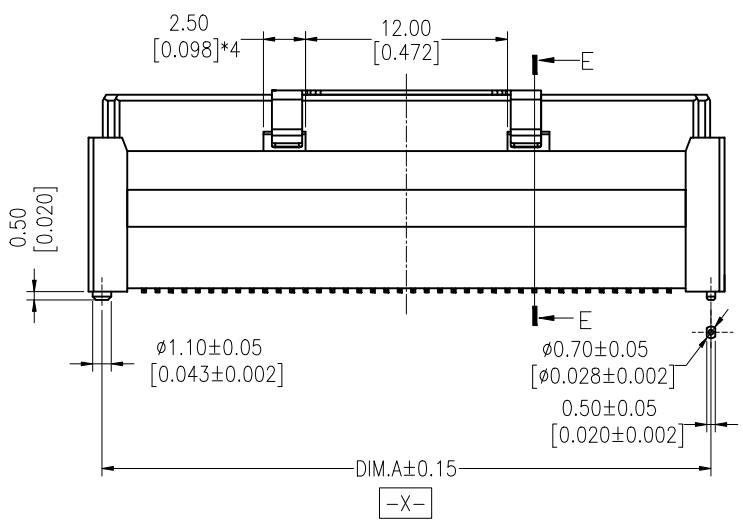

ASS'Y HEIGHT (H)	PLUG (H1)	SOCKET (H2)	PART NO.			H2	
5.00	4.60	3.75	WAFV-20XX-BN20R			3.75MM	
6.00	5.60		WAFV-40XX-BN20R			7.75MM	
7.00	6.60		WAFV-41XX-BN20R			11.75MM	
8.00	7.60	7.75	79.20	85.80	84.20	200=1F	
ASS'Y HEIGHT (H)	PLUG (H1)		SOCKET (H2)	71.20	77.80	76.20	180=1E
9.00	4.60		7.75	63.20	69.80	68.20	160=1D
10.00	5.60			55.20	61.80	60.20	140=1C
11.00	6.60			47.20	53.80	52.20	120=1B
12.00	7.60	11.75	39.20	45.80	44.20	100=1A	
ASS'Y HEIGHT (H)	PLUG (H1)		SOCKET (H2)	31.20	37.80	36.20	80
13.00	4.60		11.75	23.20	29.80	28.20	60
14.00	5.60			15.20	21.80	20.20	40
15.00	6.60	11.75					
16.00	7.60						
			DIM.C	DIM.B	DIM.A	PIN NO.	

GENERAL TOLERANCE	ANGLE TOLERANCE
X±0.50	X°±5.0°
.X±0.38	.X°±3.0°
.XX±0.25	.XX°±2.0°
.XXX±0.15	.XXX°±1.0°

DRAWN	DATE
Knight	12/18/15'
CHECKED	DATE
APPROVED	DATE
River	12/18/15'

ENESIS TECHNOLOGY INC	
TITLE: 0.80mm B TO B Female "T" TYPE SMT	
PART NUMBER: WAFV-XXXX-BN20R	
DRAWING NO. GT26-210469	SIZE A4 REV. C

ITEM	NAME	Q'TY	DESCRIPTION
3	COVER	1	SUS
2	CONTACT	XX	PHOSPHOR BRONZE,Au 3u" PLATING ON CONTACT AREA,MATTE TIN 80u" MIN PLATING SOLDER AREA,NICKEL 40u" MIN UNDER PLATING OVERALL
1	BASE	1	LCP+30%G.F

NATURAL, UL94 V-0
NOTE

MATL SEE BOM
FINISH SEE NOTES
SCALE N/A UNIT mm
SHEET 1 OF 2

PROPRIETARY INFORMATION
COMPANY CONFIDENTIAL

REV.	ECN. NO.	DESCRIPTION	ENG	DATE
A		INITIAL	Knight	05/07/15'
B		ADD ASSEMBLE VIEW	Knight	12/16/15'
C		ADD FEMALE HEIGHT 3.75MM AND 7.75MM OPTION	Knight	12/18/15'

PLUG

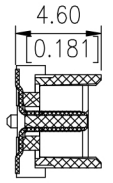

WAFV-14XX-BN20R

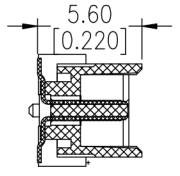

WAFV-17XX-BN20R

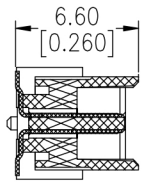

WAFV-18XX-BN20R

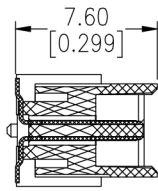

WAFV-19XX-BN20R

RECEPTACLE

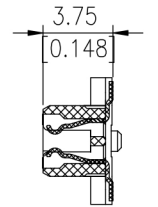

WAFV-20XX-BN20R

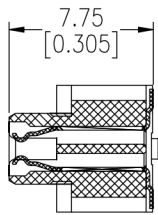

WAFV-40XX-BN20R

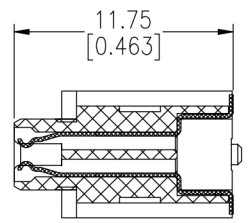

WAFV-41XX-BN20R

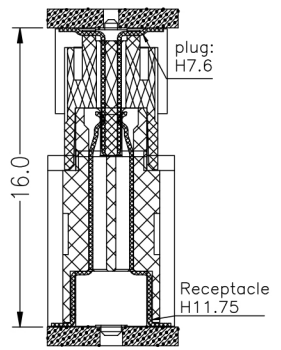
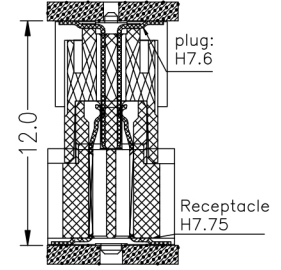
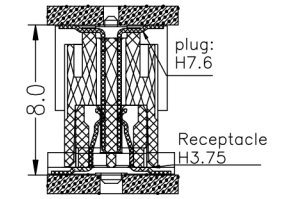
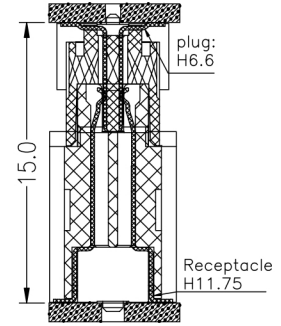
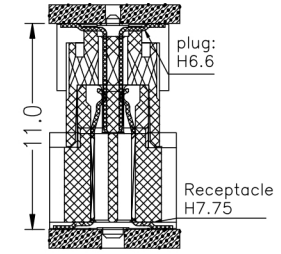
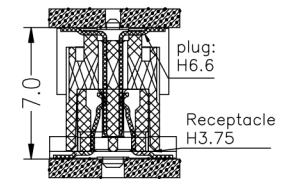
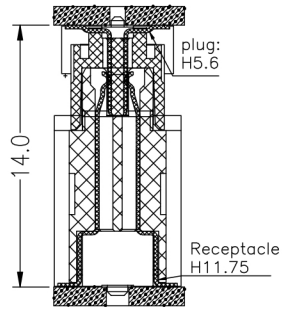
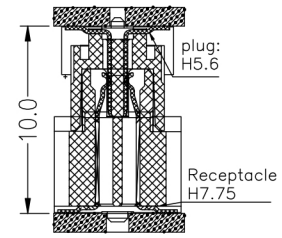
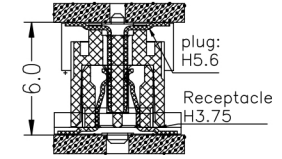
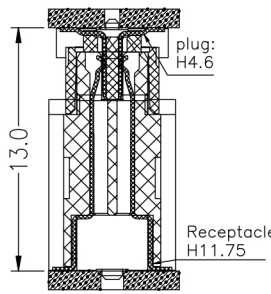
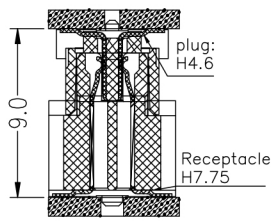
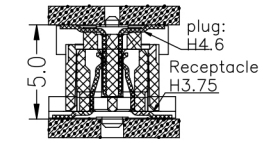

GENERAL TOLERANCE X ± 0.50 .X ± 0.38 .XX ± 0.25 .XXX ± 0.15	ANGLE TOLERANCE X° ± 5.0° .X° ± 3.0° .XX° ± 2.0° .XXX° ± 1.0°	DRAWN Knight	DATE 12/18/15'	
MATERIAL SEE BOM		CHECKED	DATE	
FINISH SEE NOTES		APPROVED River		PART NUMBER WAFV-XXXX-BN20R
SCALE N/A	UNIT mm	DATE 12/18/15'		DRAWING NO. GT26-210469
SHEET 2 OF 2				SIZE A4 REV. C