

VIEW 0
SCALE 2:1

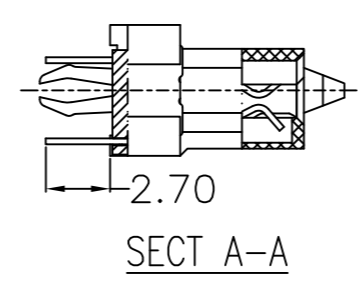

SECT A-A

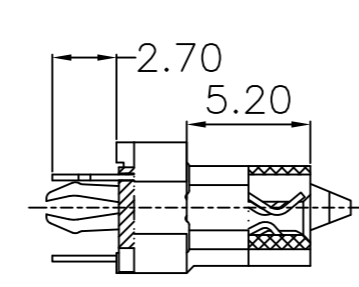
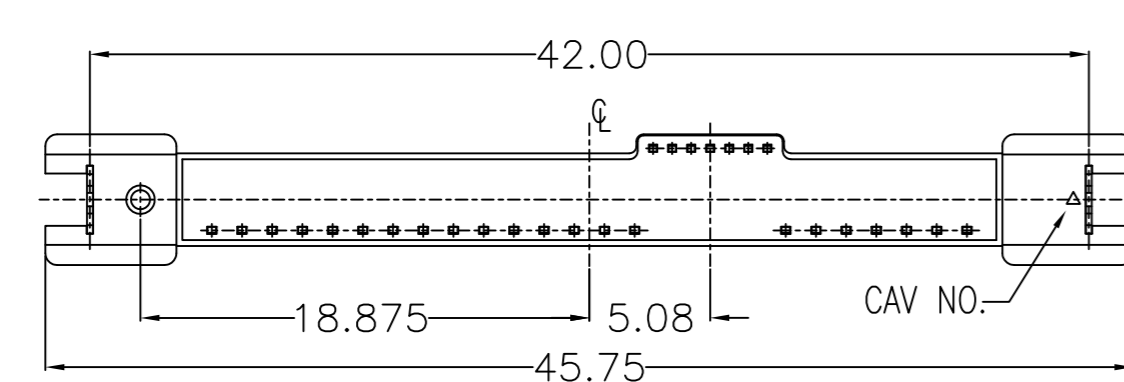

SECT B-B

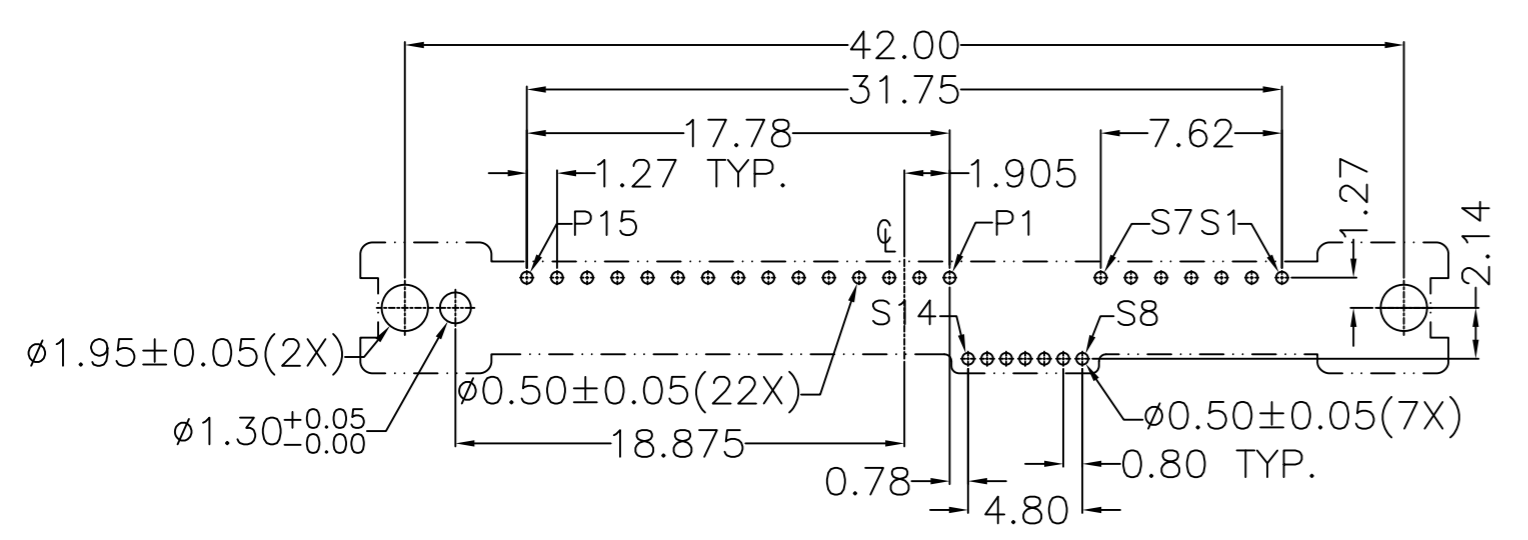

PCB LAYOUT(T=1.60mm)
COMPONENT SIDE

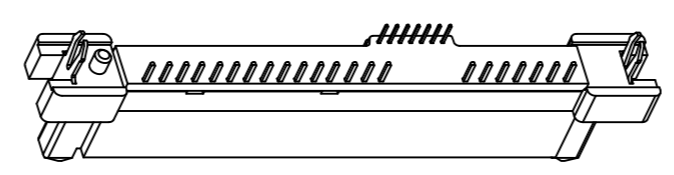

NOTES:

- MATERIAL
HOUSING: LCP+50%GF, UL 94V-0 RATED, COLOR BLACK
CONTACT: PHOSPHOR BRONZE
HARPOON: PHOSPHOR BRONZE
- PLATING
CONTACT: GOLD 30u" MIN. PLATING ON CONTACT AREA,
TIN 80u" MIN. PLATING ON SOLDER TAIL,
NICKEL 30u" MIN. UNDERPLATING OVERALL
HARPOON: TIN 80u" MIN. PLATING OVER NICKEL 30u" MIN.
- MECHANICAL
INSERTION FORCE: 25N MAX.
WITHDRAWAL FORCE: 5N MIN.
DURABILITY: 500 CYCLES
- ELECTRICAL SPECIFICATION
CURRENT RATING: 1.5 AMPERE PER CONTACT
CONTACT RESISTANCE: 30 mΩ MAX.
INSULATION RESISTANCE: 1000 MΩ MIN.
DIELECTRIC WITHSTANDING VOLTAGE: 500 VAC
- OPERATING TEMPERATURE: 0°C TO +55°C
- RoHS COMPLIANT

ORDER INFORMATION
SASV - 27 29 - B K 6 0 U 1F
① ② ③ ④ ⑤ ⑥ ⑦ ⑧

- CONNECTOR:
SASV: SAS CONNECTOR
- TYPE:
27: SAS 29P STRAIGHT DIP FEMALE LOCK KEY
- POSITIONS:
29: 29 POSITIONS
- INSULATOR MATERIAL:
B: LCP
- INSULATOR COLOR:
K: BLACK
- CONTACT PLATING:
6: GOLD 30u" MIN.
- SHIELD PLATING:
0: WITHOUT SHIELD
- PACKING:
U: TUBE

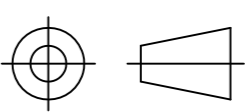
TOLERANCE				TITLE: SAS 29P STRAIGHT DIP FEMALE LOCK KEY				
LINEAR	ANGLES			PART NO. SASV-2729-BK60U1F		DWG NO. GTi10-20191		
X. ±	X° ± 3°	APPD:	MAT'L:		UNITS	SCALE	SHEET	REV
.X ± 0.38	.X° ±	CHKD:	FINISH:		MM	NONE	1 OF 1	A
.XX ± 0.25	.XX° ±	DRWN: Jeff	Q'TY:					
.XXX ± 0.20	.XXX° ±							

A	FIRST RELEASE	Jeff	11/24/10'
REV	ECN NO.	NAME	DATE